

# Cree® EZ700-n™ Gen 2 LED

## Data Sheet (Cathode-up)

### CxxxEZ700-Sxx000-2

Cree's EZBright® LEDs are the latest generation of solid-state n-pad up LED emitters that combine highly efficient InGaN materials with Cree's proprietary optical design and device technology to deliver superior value for high-intensity LEDs. The optical design maximizes light extraction efficiency and enables a Lambertian radiation pattern. Additionally, these LEDs are die attachable with conductive epoxy, solder paste or solder preforms, as well as the flux eutectic method. These vertically structured, low forward voltage LED chips are approximately 170 microns in height. Cree's EZ™ chips are tested for conformity to optical and electrical specifications. These LEDs are useful in a broad range of applications, such as general illumination, automotive lighting and LCD backlighting.

#### FEATURES

- EZBright Power Chip LED Rf Performance
  - 450 nm - 240+ mW
  - 460 nm - 240+ mW
  - 470 nm - 240+ mW
  - 527 nm - 90+ mW
- Lambertian Radiation
- Conductive Epoxy, Solder Paste or Preforms, or Flux Eutectic Attach
- Low Forward Voltage – 3.25 V typ at 350 mA
- Single Wire Bond Structure
- Dielectric Passivation Across Epi Surface

#### APPLICATIONS

- General Illumination
  - Aircraft
  - Decorative Lighting
  - Task Lighting
  - Outdoor Illumination
  - Projection Lighting
- White LEDs
- Crosswalk Signals
- Backlighting
- Automotive

#### CxxxEZ700-Sxx000-2 Chip Diagram

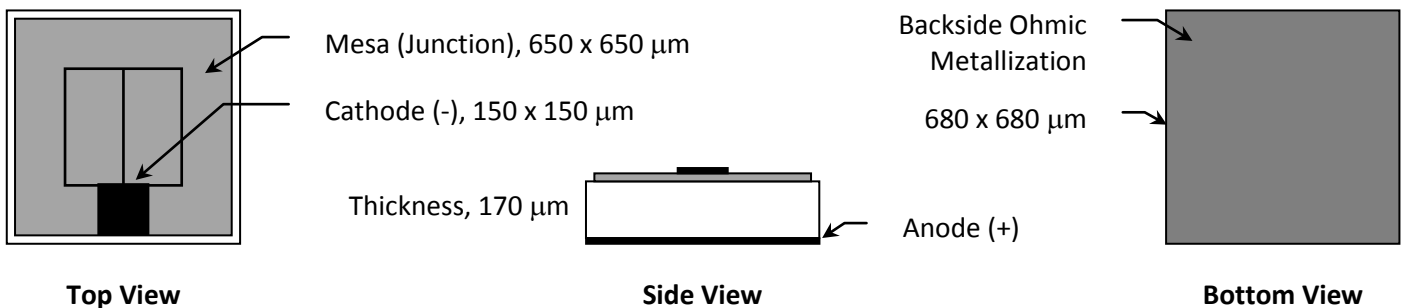

Maximum Ratings at $T_A = 25^\circ\text{C}$ <small>Notes 1, 2 &amp; 3</small>		CxxxEZ700-Sxx000-2
DC Forward Current		750 mA
Peak Forward Current (1/10 duty cycle @ 1 kHz)		1000 mA
LED Junction Temperature		150°C
Reverse Voltage		5 V
Operating Temperature Range		-40°C to +100°C
LED Chip Storage Temperature Range (LED Chip storage only, not for Die Sheet Storage)		-40°C to +120°C
Recommended Die Sheet Storage Conditions		$\leq 30^\circ\text{C}$ / $\leq 85\%$ RH

Typical Electrical/Optical Characteristics at $T_A = 25^\circ\text{C}$ , $I_f = 350\text{ mA}$ <small>Note 2</small>					
Part Number	Forward Voltage ( $V_f$ , V)			Reverse Current [ $I(V_r=5\text{ V})$ , $\mu\text{A}$ ]	Full Width Half Max ( $\lambda_d$ , nm)
	Min.	Typ.	Max.	Max.	Typ.
C450EZ700-Sxx000-2	3.0	3.25	3.7	2	20
C460EZ700-Sxx000-2	3.0	3.25	3.7	2	21
C470EZ700-Sxx000-2	3.0	3.25	3.7	2	22
C527EZ700-Sxx000-2	3.1	3.35	3.8	2	35

Mechanical Specifications		CxxxEZ700-Sxx000-2	
Description	Dimension	Tolerance	
P-N Junction Area ( $\mu\text{m}$ )	650 x 650	$\pm 35$	
Chip Area ( $\mu\text{m}$ )	680 x 680	$\pm 35$	
Chip Thickness ( $\mu\text{m}$ )	170	$\pm 25$	
Top Au Bond Pad ( $\mu\text{m}$ )	150 x 150	$\pm 25$	
Au Bond Pad Thickness ( $\mu\text{m}$ )	3.0	$\pm 1.5$	
Back Ohmic Metal Area ( $\mu\text{m}$ )	680 x 680	$\pm 35$	
Back Ohmic Metal Thickness ( $\mu\text{m}$ )	3.0	$\pm 1.5$	

**Notes:**

- Maximum ratings are package-dependent. The above ratings were determined using a silicone encapsulated chip on MCPCB for characterization. Ratings for other packages may differ. The junction temperature should be characterized in a specific package to determine limitations. Assembly processing temperature must not exceed 325°C (< 5 seconds). See Cree EZBright Applications Note for assembly-process information.
- All products conform to the listed minimum and maximum specifications for electrical and optical characteristics when assembled and operated at 350 mA within the maximum ratings shown above. Efficiency decreases at higher currents. Typical values given are within the range of average expected by the manufacturer in large quantities and are provided for information only. All measurements were made using a Au-plated TO header without an encapsulant. Optical characteristics measured in an integrating sphere using Illuminance E.
- The maximum forward current is determined by the thermal resistance between the LED junction and ambient. It is crucial for the end-product to be designed in a manner that minimizes the thermal resistance from the LED junction to ambient in order to optimize product performance.

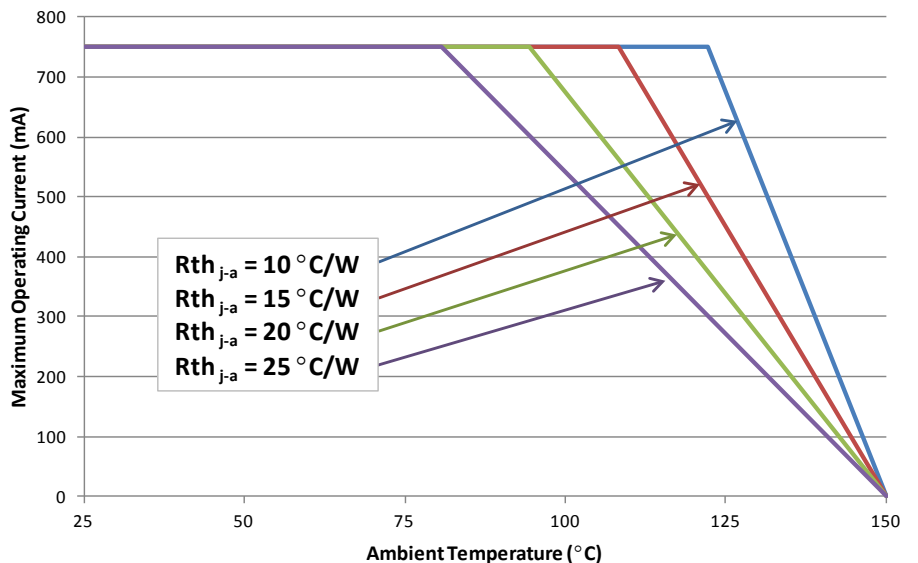

## Standard Bins for CxxxEZ700-Sxx000-2

LED chips are sorted to the **radiant flux** and **dominant wavelength** bins shown. A sorted die sheet contains die from only one bin. Sorted die kit (CxxxEZ700-Sxx000-2) orders may be filled with any or all bins (CxxxEZ700-0xxx-2) contained in the kit. All radiant flux and all dominant wavelength values shown and specified are at  $I_f = 350 \text{ mA}$ . Radiant flux values are measured using Au-plated headers without an encapsulant.

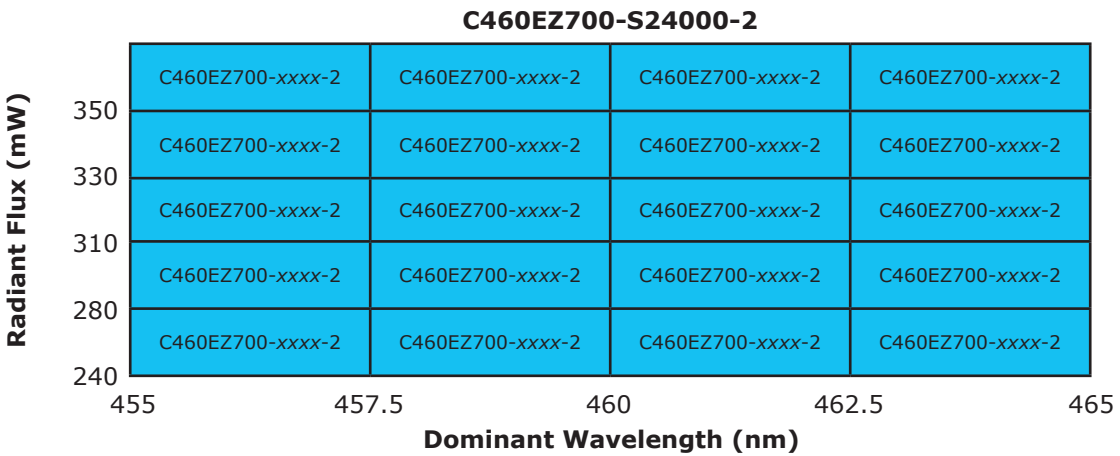
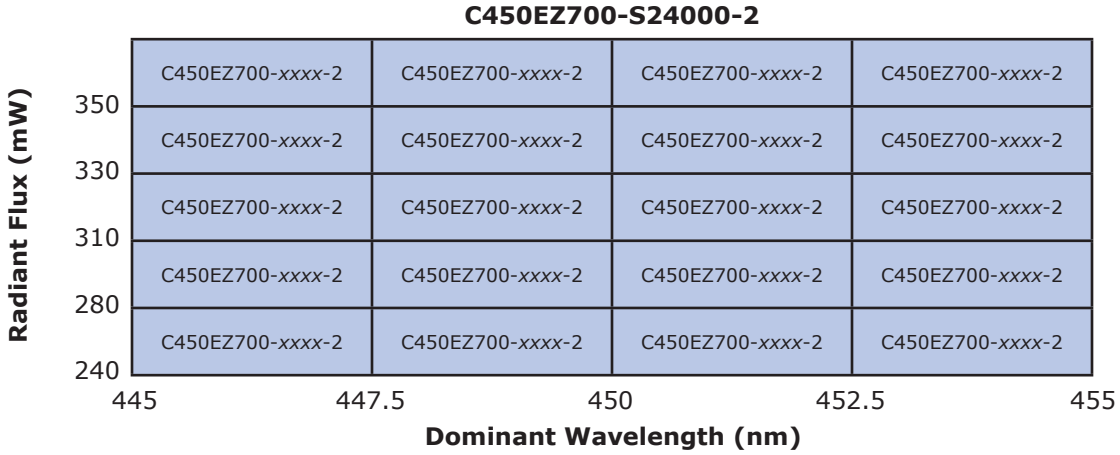

## Standard Bins for CxxxEZ700-Sxx000-2

LED chips are sorted to the **radiant flux** and **dominant wavelength** bins shown. A sorted die sheet contains die from only one bin. Sorted die kit (CxxxEZ700-Sxx000-2) orders may be filled with any or all bins (CxxxEZ700-0xxx-2) contained in the kit. All radiant flux and all dominant wavelength values shown and specified are at  $I_f = 350$  mA. Radiant flux values are measured using Au-plated headers without an encapsulant.

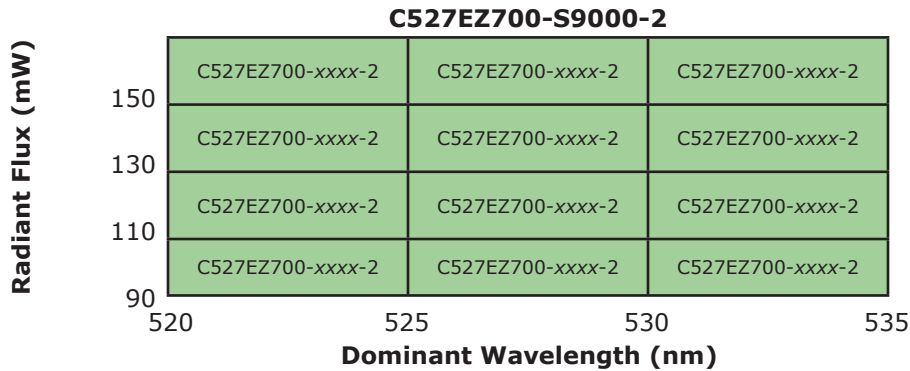
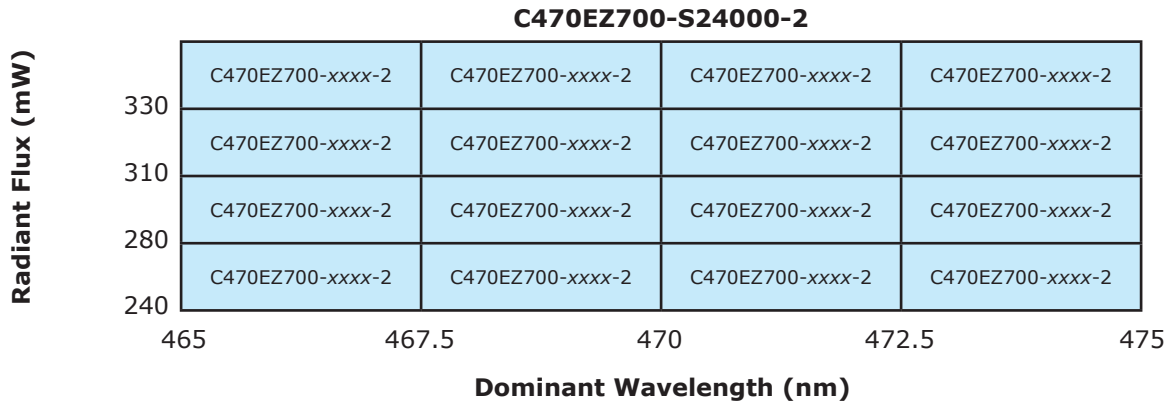

## Characteristic Curves

These are representative measurements for the EZBright Power Chip LED product. Actual curves will vary slightly for the various radiant flux and dominant wavelength bins.

**Forward Current vs. Forward Voltage**

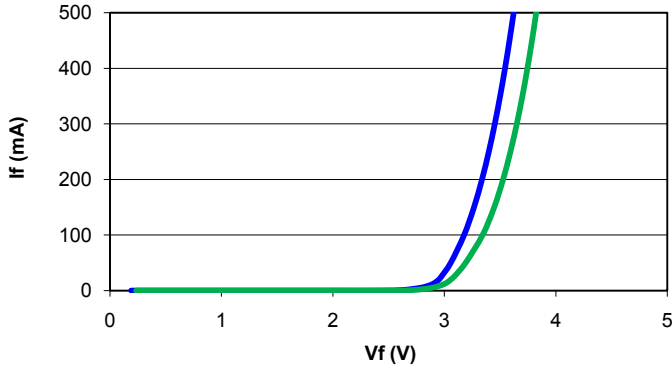

**Voltage Shift vs. Junction Temperature**

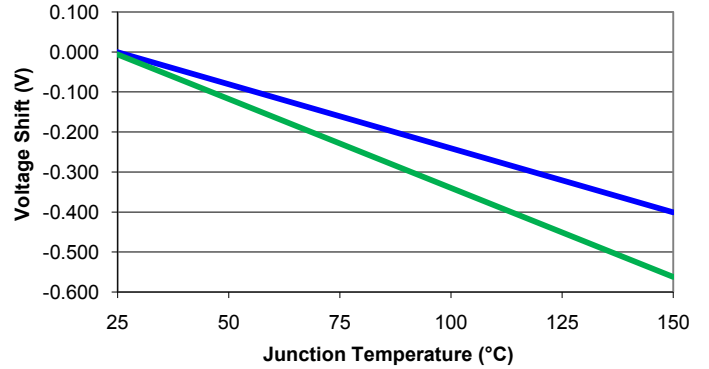

**Relative Intensity vs. Forward Current**

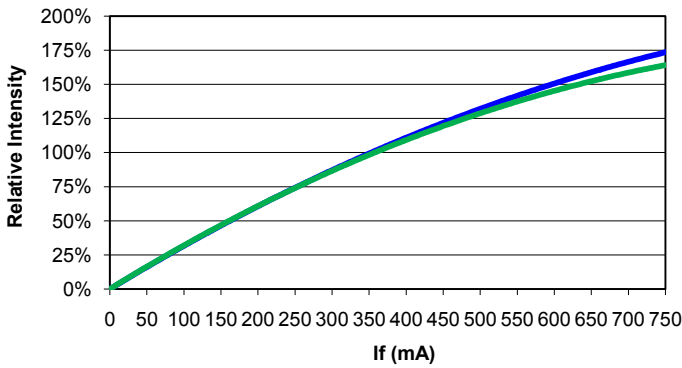

**Relative Light Intensity vs. Junction Temperature**

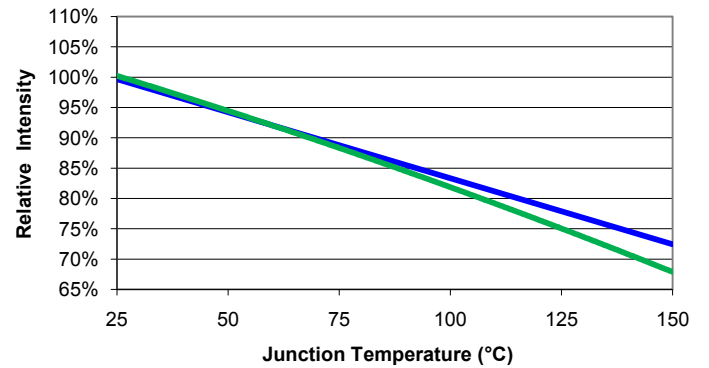

**Wavelength Shift vs. Forward Current**

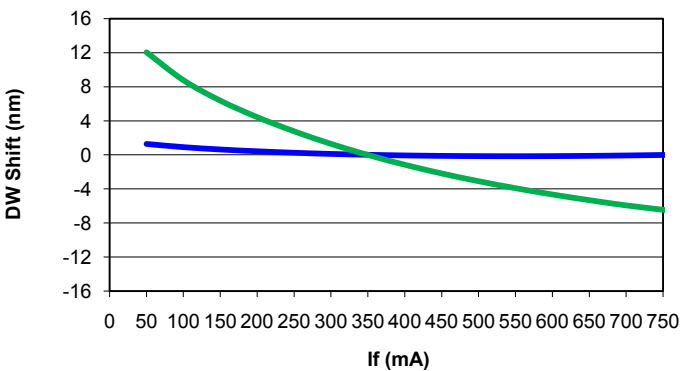

**Dominant Wavelength Shift vs. Junction Temperature**

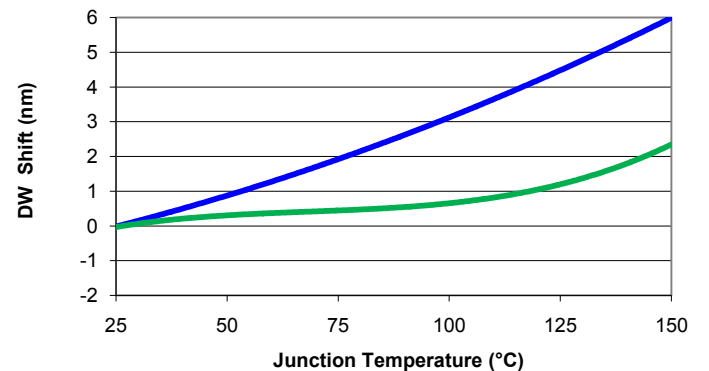

## Radiation Pattern

This is a representative radiation pattern for the EZBright Power Chip LED product. Actual patterns will vary slightly for each chip.

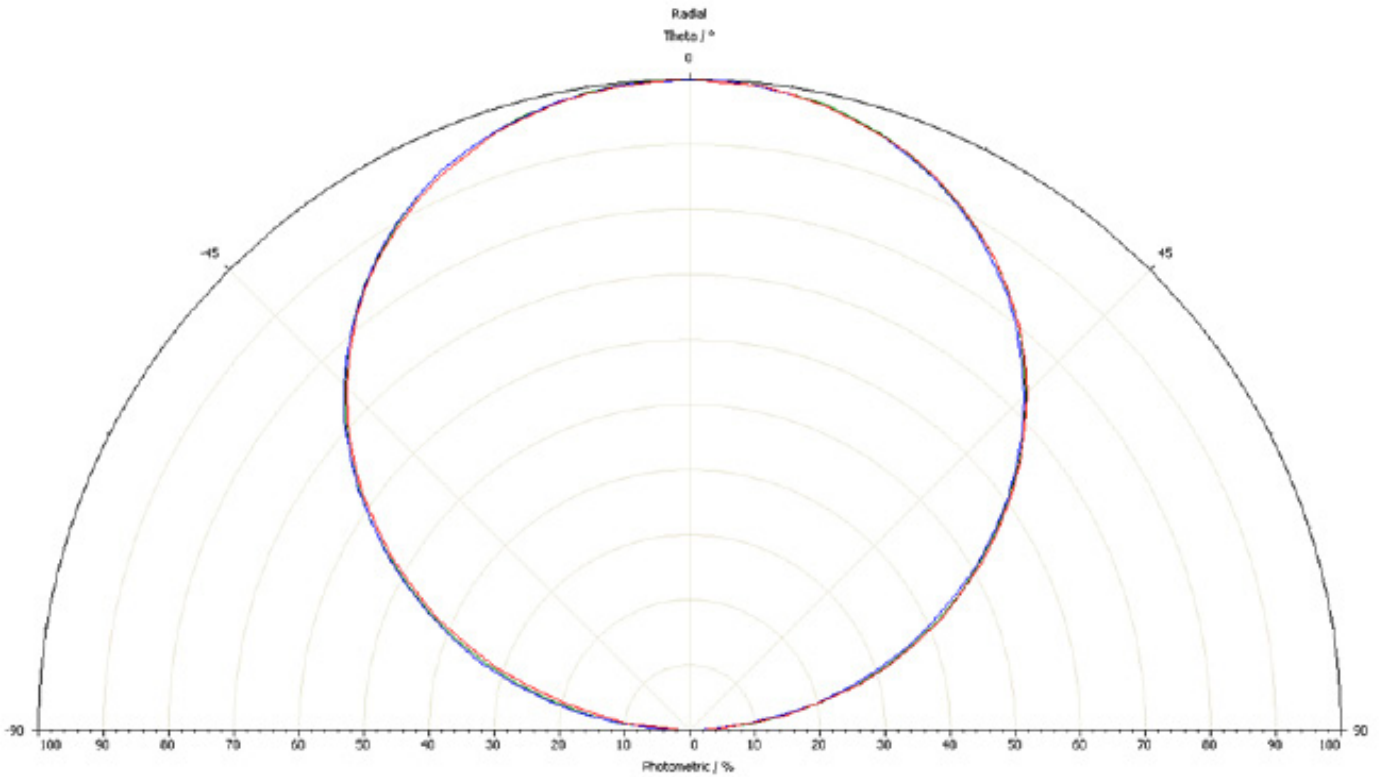

## Product Content Information and Warnings

**This information is not intended as legal advice. Consult a qualified lawyer if you are unfamiliar with the applicability of China RoHS 2 and/or California Proposition 65 to your business and products.**

### China RoHS 2

	<p>This green "e" logo is included on this product datasheet to indicate that the Cree product described herein does not include any of chemicals regulated under China RoHS 2 above permissible threshold limits. As applicable, each customer that incorporates this Cree product into its higher-level product needs to decide on the appropriate China RoHS 2 label for its higher-level product based on any other regulated content used in its product. If no other regulated content is present, this green "e" logo also may be used for the customer's product.</p>
---	---

Pursuant to Management Methods for Restricted Use of Hazardous Substances in Electrical and Electronic Products, an administrative order published by the Chinese Ministry of Industry and Information Technology (MIIT) and effective as of July 1, 2016 (more commonly known as "China RoHS 2"), electronic and electrical end products (EEPs) sold into China must be marked with a logo to indicate whether or not they contain any of the chemicals regulated under China RoHS 2 (i.e., lead, mercury, cadmium, hexavalent chromium, polybrominated biphenyls, or polybrominated diphenyl ethers) above the permissible threshold limits. As of March 2018, the list of EEPs includes refrigerators, air conditioners, washing machines, water heaters, printers, copiers, fax machines, TV sets, monitors, microcomputers, cell phones, and telephones. This list is subject to modification by the MIIT.

According to MIIT guidance, suppliers supporting the manufacture of EEPs (i.e., component suppliers) may—but are not required to—include a label on their component products. However, if a component product includes one of the regulated substances, the component supplier must provide the purchaser with information in a prescribed tabular format to facilitate labeling EEPs. The table must disclose the type and location of the hazardous substances contained in the component product. If a component product that could be used in an EEP is sold separately in the market, the component product falls within the scope of China RoHS unless the final purpose is known to be out of scope. A supplier that does not directly sell products in China should nevertheless comply with China RoHS 2 if there is a possibility that its products or products incorporating its products will be sold in China. For more information about China RoHS, please refer to <http://www.chinarohs.com/docs.html>.

### California Proposition 65 Warnings

This Cree semiconductor die product (excluding packaging) does not contain any chemicals that must be disclosed under California Proposition 65 (officially titled the Safe Drinking Water and Toxic Enforcement Act of 1986, codified at Cal. Health & Saf. Code §§ 25249.5–.13) enacted by the State of California. This die product, however, is packaged using PVC die transfer film that contains Diisononyl Phthalate (DINP), a chemical known to the State of California to cause cancer and/or birth defects or other reproductive harm. If you are located in the State of California, the presence of DINP in the PVC die transfer film results in the need for you to provide an occupational warning under Proposition 65. Pursuant to California Health and Safety Code § 25606, you must post Proposition 65 compliant warnings at your place(s) of business in California to warn your employees and contractors who may come into contact with the PVC die transfer film during use and handling of the Cree die products, including in connection with the development or manufacture of higher-level products. Specifically, for indoor environments or outdoor spaces with clearly defined entrances, a warning sign must be posted at all public entrances to the affected area and, in no smaller than 72-point type, read substantially as follows:

	<p><b>WARNING:</b> Entering this area may expose you to Diisononyl Phthalate (DINP), a chemical known to the State of California to cause cancer and birth defects or other reproductive harm. DINP is present in the PVC die transfer film on which certain semiconductor die products sold by Cree, Inc. or one of its affiliates are delivered. Please refer to the Cree website at <a href="http://www.cree.com/prop65-creecomponents">www.cree.com/prop65-creecomponents</a> to verify which Cree semiconductor die products are delivered on this type of PVC die transfer film. For more information on California's Proposition 65 warnings, go to <a href="http://www.P65Warnings.ca.gov">www.P65Warnings.ca.gov</a>.</p>
---	--

This occupational warning must be provided in English and in any other language used on other signage in the affected area. Since the Cree die products themselves do not contain DINP, their incorporation into your products will not create an obligation for you to include a Proposition 65 warning on your products. Please ensure that the PVC die transfer film is properly handled and properly disposed of as a hazardous material after die removal.

Please refer to the Cree website at [www.cree.com/prop65-creecomponents](http://www.cree.com/prop65-creecomponents) to verify which Cree semiconductor die products are delivered on this type of PVC die transfer film.